

Type 8051 can be combined with...

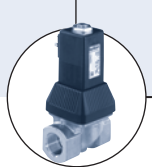

Type 6223

Solenoid control valve



Type 2731 (8630)

TopControl system

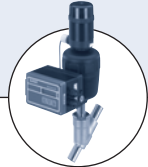

Type 2702 (1067)

SideControl system

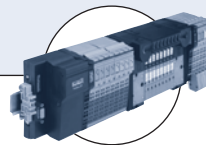

Type 8644

Valve islands

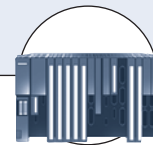

PLC

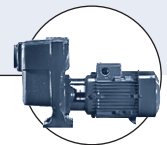

Pumps

Full Bore Magflowmeter for Low-flow measurement

- Combination of magflowsensor body S051 and transmitter / batch controller SE56
- Continuous measurement or Batch Control
- Clean in place (CIP)
- Low-flow measurements down to 3 l/h

The complete full bore magflowmeter Type 8051, which consists of a magnetic sensor body Type S051 connected to a flow transmitter / batch controller Type SE56 (blind in compact version or with display in compact or separate version), is designed for applications with conductivities as low as 5 $\mu\text{S}/\text{cm}$.

Combined with a valve as the actuating element, the complete full bore magflowmeter Type 8051 can control high-precision dosing and filling operations.

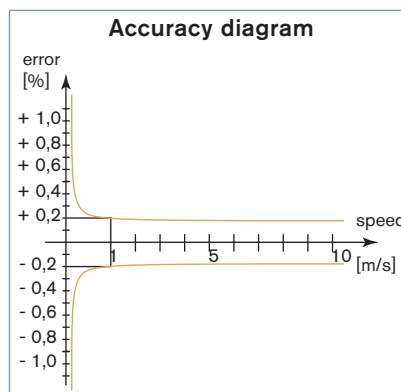

Tri-Clamp® is a registered Trademark of Alfa Laval Inc.

Technical data

General data - S051 sensor body

Compatibility	SE56 electronics (see corresponding datasheet)
Materials	
Body	Stainless steel 304 (1.4301)
Wetted parts (connection)	Stainless steel 316L (1.4404) or 304 (1.4301) for full lining
Electrode	Stainless steel 316L
Lining / Gasket	[Hastelloy C, Titanium, Tantalum, Platinum-rhodium on request]* PTFE / FKM, EPDM or FFKM
Electrical connection	2 cable glands (PG9)

Complete system data 8051 (S051 sensor + SE56 electronics)

Pipe diameter	DN 03 up to DN 20
Measuring range	0 ... 10 l/h up to 0 ... 12 500 l/h
Process connection	Thread ISO 228-1, NPT (DIN 11851, SMS 1145, Tri-Clamp® ISO 2852 or BS 4825, Flanges DIN 2501, ANSI on request)
Medium temperature	
Compact version	-20 up to 100°C (with display version)
Separate version	-20 up to 100°C (with blind version) [up to 130°C for max. 1 hour] -20 up to 150°C
Medium pressure max.	PN 16 (PN40, on request)
Vacuum resistance	200 mbar absolute at 100°C
Accuracy ¹⁾	± 0.2% of reading (see diagram, opposite)
Repeatability	< 0.1%
Minimum conductivity	5 $\mu\text{S}/\text{cm}$ (or 20 $\mu\text{S}/\text{cm}$ with demineralized water)
Environment - S051 sensor body	
Ambient temperature	-20 up to: 60°C (with display version) or 40°C (with blind version)
Standard - S051 sensor body	
Protection class	IP67 (Compact version); IP68 (Separate version)
Standard	EN55011 (Group 1, Class B)
EMI / Safety	IEC1000-4-2/3/4/5/6/11 / EN61010

¹⁾ under reference conditions: water temperature = 20°C, ambient temperature = 25°C, test time > 60 s., converter warm-up > 60', constant flow rate during the test, pressure = 500 mbar, liquid speed > 1 m/s
* on request

Ordering information for complete full bore magflowmeter Type 8051

A complete full bore magflowmeter Type 8051 consists of a sensor body S051 and an electronic transmitter / batch controller SE56. The transmitter / batch controller is only delivered in combination with the sensor body as a part of a complete magflowmeter.

The following information is necessary for the selection of a complete full bore magflowmeter:

- **item no** of the sensor body **Type S051** (see Ordering Chart)
- **item no** of the transmitter / batch controller **Type SE56** (see separate datasheet or Ordering chart on page 5)

More info.

For more technical information about this product, click on this box... you will come to our website for this product where you can download the datasheet.

Examples for variations of complete full bore magflowmeter

Transmitter / batch controller Type SE56

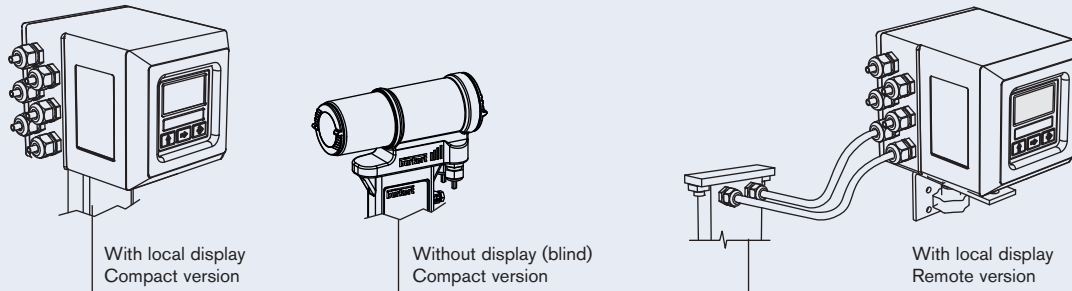

Magnetic sensor body Type S051

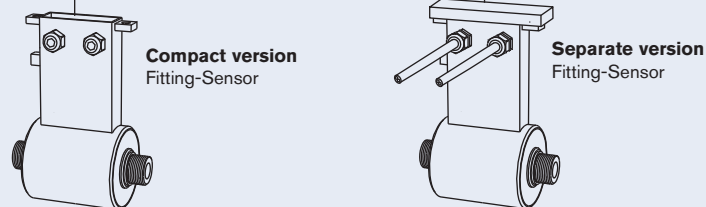

Design and operating principle

The sensor body Type S051 consists of a stainless steel pipe section internally lined with insulating material. Two electrodes mounted opposite to each other on the internal surface of the tube generate an electrical signal. The coils generating the magnetic field are placed outside the pipe.

The signal generated by the sensor body S051 must be amplified and processed by an electronic transmitter / batch controller (SE56) which outputs an electrical signal proportional to the fluid flow rate, and powers the coils generating the magnetic field.

Faraday's induction law is the basis for this magnetic flow measurement.

Installation



Avoid the functioning with the pipe partially empty.

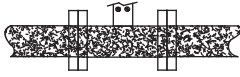

During the functioning the pipe must be completely full.

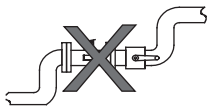

Avoid the installation near curves or hydraulic accessories.

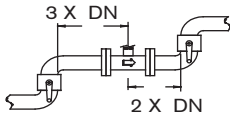

Observe the upstream and downstream distances.

The flow rate sensor body can be installed into either horizontal or vertical pipes. Mount the S051 sensor body in these correct ways to obtain an accurate flow measurement.

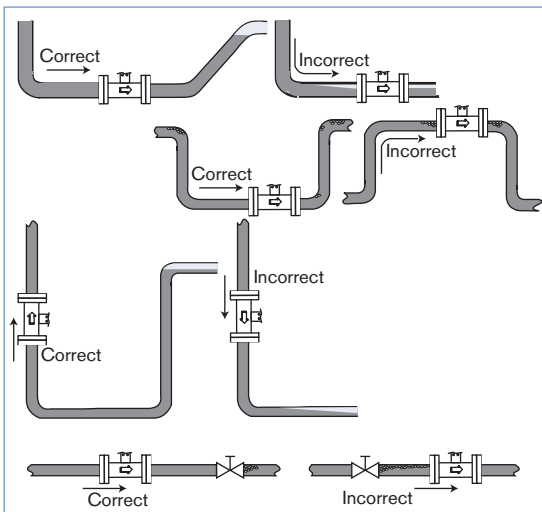

The suitable pipe size is selected using the diagram Flow / Velocity / DN, upside.
The flow sensor body is not designed for gas flow measurement.

Selection of fitting / pipe size

Example:

- Specification of nominal flow: 10 l/min
- Ideal flow velocity: 2...3 m/s
- For these specifications, the diagram indicates a pipe size of DN10

Flow rate

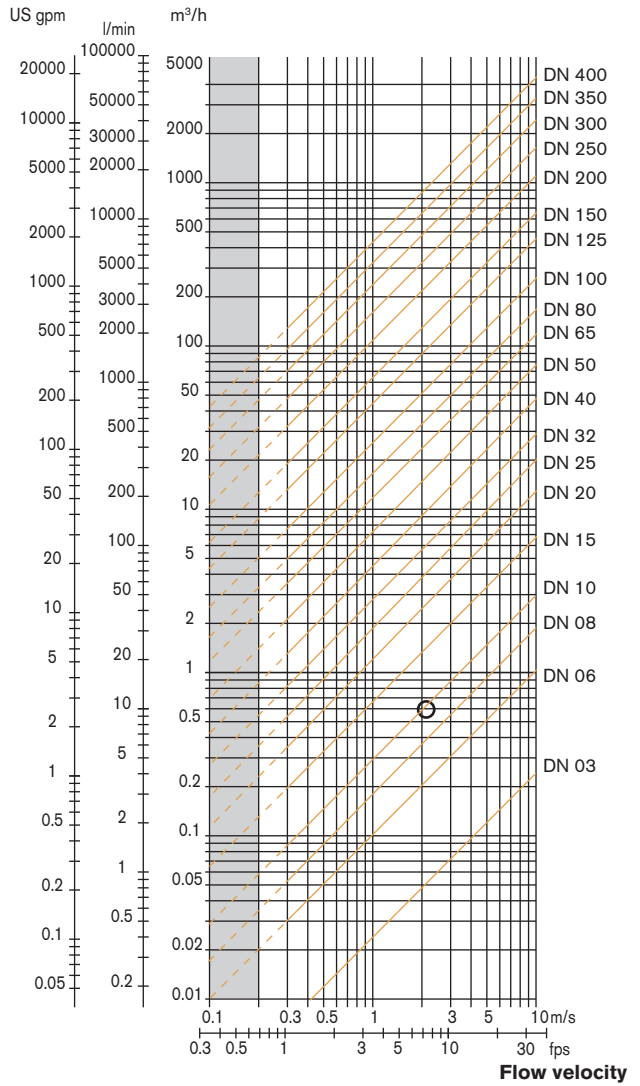

Dimensions [mm] of Type S051 standard sensor body (without full lining)

NOTE: Dimensions of SE56 flowtransmitter, see corresponding datasheet.

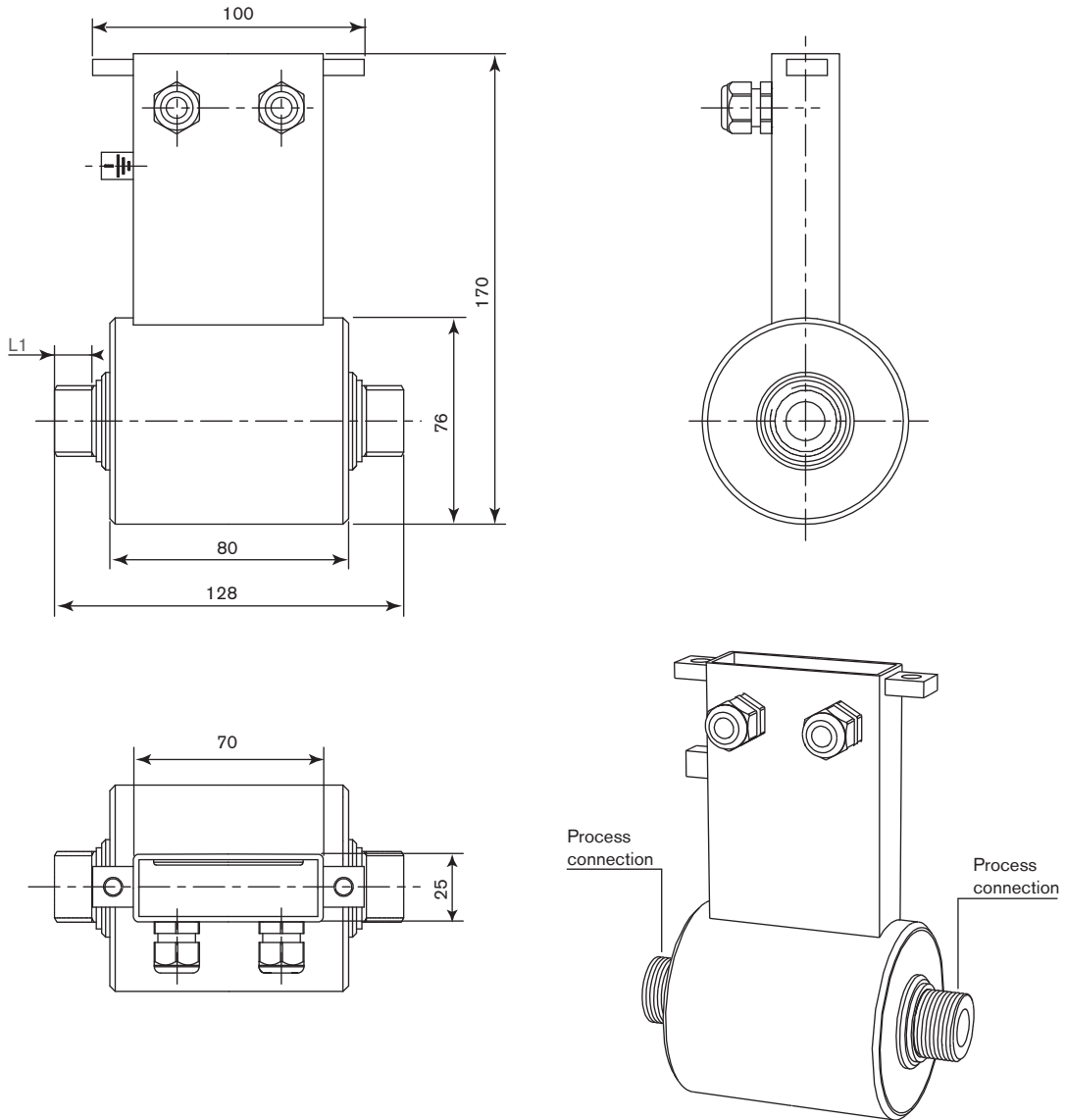

DN [mm]	Thread [inch]	L1 [mm]
03	G or NPT 1/4"	16.4
06	G or NPT 3/8"	16.4
10	G or NPT 1/2"	17.4
15	G or NPT 3/4"	20.0
20	G or NPT 1"	20.0

Ordering charts for Low-flow magflowmeter 8051

A complete magflowmeter Type 8051 consists of: - a full bore sensor body Type S051
- a flow transmitter / batch controller Type SE56

Please order the relevant sensor body and the flow transmitter / batch controller separately!

Full bore Sensor body Type S051

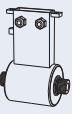
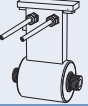
Description	Orifice [mm]	Process connection	Flow rate range [l/h]		Body material	Wetted parts material	Lining material	Item no.
			min. 0...0.4 m/s	max. 0...10 m/s				
 Compact version	03	G1/4" (ISO 228-1)	0 ... 10	0 ... 250	SS 304	SS 316L	PTFE	554 321
		NPT1/4"	0 ... 10	0 ... 250	SS 304	SS 316L	PTFE	554 213
	06	G3/8" (ISO 228-1)	0 ... 40	0 ... 1000	SS 304	SS 316L	PTFE	553 065
		NPT3/8"	0 ... 40	0 ... 1000	SS 304	SS 316L	PTFE	555 892
	10	G1/2" (ISO 228-1)	0 ... 120	0 ... 3000	SS 304	SS 316L	PTFE	553 374
		NPT1/2"	0 ... 120	0 ... 3000	SS 304	SS 316L	PTFE	555 111
	15	G3/4" (ISO 228-1)	0 ... 240	0 ... 6000	SS 304	SS 316L	PTFE	553 481
		NPT3/4"	0 ... 240	0 ... 6000	SS 304	SS 316L	PTFE	557 659
20	G1" (ISO 228-1)	0 ... 500	0 ... 12500	SS 304	SS 316L	PTFE	553 539	
	NPT1"	0 ... 500	0 ... 12500	SS 304	SS 316L	PTFE	553 663	
 Separate version - with 10 m cable (included)	03	G1/4" (ISO 228-1)	0 ... 10	0 ... 250	SS 304	SS 316L	PTFE	448 487
	06	G3/8" (ISO 228-1)	0 ... 40	0 ... 1000	SS 304	SS 316L	PTFE	448 488
	10	G1/2" (ISO 228-1)	0 ... 120	0 ... 3000	SS 304	SS 316L	PTFE	448 489
	15	G3/4" (ISO 228-1)	0 ... 240	0 ... 6000	SS 304	SS 316L	PTFE	448 490
	20	G1" (ISO 228-1)	0 ... 500	0 ... 12500	SS 304	SS 316L	PTFE	448 491

Flow transmitter Type SE56 (for more data, refer to datasheet Type SE56)

Description	Power supply	Outputs	Body material	Electrical connection	Item no.
With local display compact version	90 - 265 V AC	2 transistors	Aluminium	6 cable glands	558 745
			Stainless steel	6 cable glands	559 780
		2 transistors + 4...20 mA	Aluminium	6 cable glands	558 747
			Stainless steel	6 cable glands	558 306
With local display remote version	90 - 265 V AC	2 transistors	Aluminium	6 cable glands	559 781
			Stainless steel	6 cable glands	558 310
		2 transistors + 4...20 mA	Aluminium	6 cable glands	558 750
			Stainless steel	6 cable glands	558 308
Blind compact version	20 - 30 V DC	Transistor	Stainless steel	2 cable glands	559 132
		Transistor + 4...20 mA	Stainless steel	2 cable glands	559 133
		Transistor + Profibus DP	Stainless steel	2 cable glands	559 134

i Further versions on request

Please also use the "request for quotation" form on page 6 for ordering a customized Low-flow sensor body. [go to page](#)

Ordering chart for spare parts/accessories for sensor body Type S051

Description	Item no.
Electrodes cable for connection between Low-flow sensor body and electronics Type SE56*, Polyolefina insulation, 10 m long	448 518
Coils cable for connection between Low-flow sensor body and electronics Type SE56*, 10 m long	448 519

* see corresponding datasheet

Low-flow sensor body Type S051 - request for quotation

Note

You can fill out the fields directly in the PDF file before printing out the form.

Please fill out and send to your nearest Bürkert facility* with your inquiry or order.

NOTE : Please take into account that the sensor body Type S051 must be associated with the electronic Type SE56.

Company:	Contact person:
Customer No.:	Department:
Address:	Tel. / Fax.:
Postcode / Town:	E-mail:

Full Bore Magflow sensor body S051

Quantity: Desired delivery date:

■ Pipe diameter: DN 03 DN 06 DN 10 DN 15 DN 20

■ Process fitting connection:

External thread ISO 228-1 DIN 11851

NPT SMS 1145

Tri-Clamp® ISO 2852 BS 4825

Flange DIN 2501 ANSI

■ Pressure: PN16 PN40

■ Materials:

Seal FKM EPDM FFKM

Wetted parts 316L 304 and PTFE full lining

Electrodes ¹⁾ 316L (2 M.E.)* Hastelloy (2 M.E. + 2 G.E.)* Tantalum (2 M.E. + 2 G.E.)*

Titanium (2 M.E. + 2 G.E.)* Platinum (2 M.E. + 2 G.E.)*

* M.E. = measuring electrode and G.E. = ground electrode

■ Sensor body version: Compact Separate

¹⁾ If the pipe is in plastic then it is advised to choose 3 electrodes, if it is in metal then 2 electrodes are enough.

*To find your nearest Bürkert facility, click on the orange box →

www.burkert.com